



Forced Air Conveyor Dryers

- Cure plastisol, water-based, and digital inks. Unique with an ink mode switch.

Capacities

| Ink Type | Shirts/Hr |
|-------------|-----------|
| Plastisol | 400+ |
| Water-Based | 80+ |
| Digital | 40+ |

- Greater production and a better “feel” on direct-to-garment prints



- Closed loop solid-state digital temperature controller



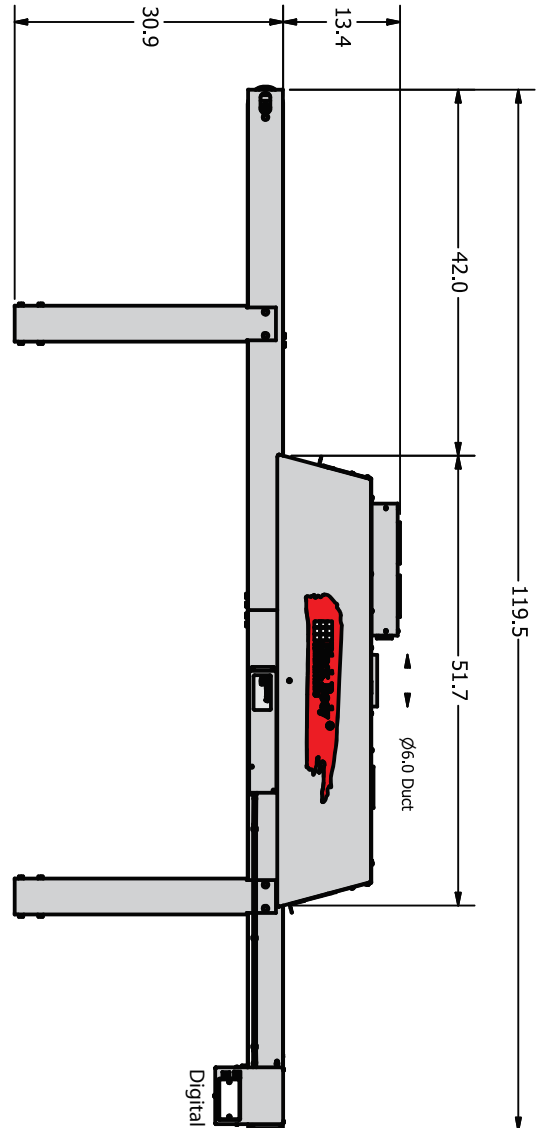
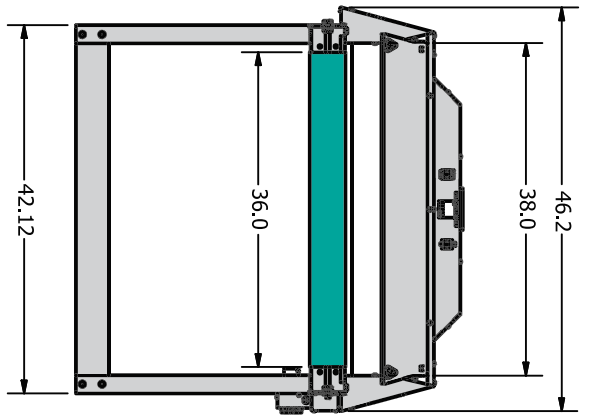

| Model No | BBAIR-2408 | BBAIR-3610 |
|---------------------------|----------------------|-------------------------|
| Length | 8 ft. | 10 ft. |
| Belt Width | 24" | 36" |
| Heat Control | Digital | Digital |
| Heater Wattage | 10.5 kW Max | 16 kW Max |
| Heater Dimensions | (2) 18" x 24" | (2) 18" x 36" |
| Heater Power Required | 208/240V 43.8/38.0 A | 59/68A 1PH - 34/40A 3PH |
| Heater Plug Type | Not Supplied | Not Supplied |
| Belt Drive Speeds | 1-12 FPM | Digital 1-15 FPM |
| Belt Drive Power Required | 120 VAC | Single Point Power |
| Approx. Shipping Weight | 480 lbs. NO CRATING | 1100 lbs. CRATE NEEDED |

BBAIR-3610 dimensions

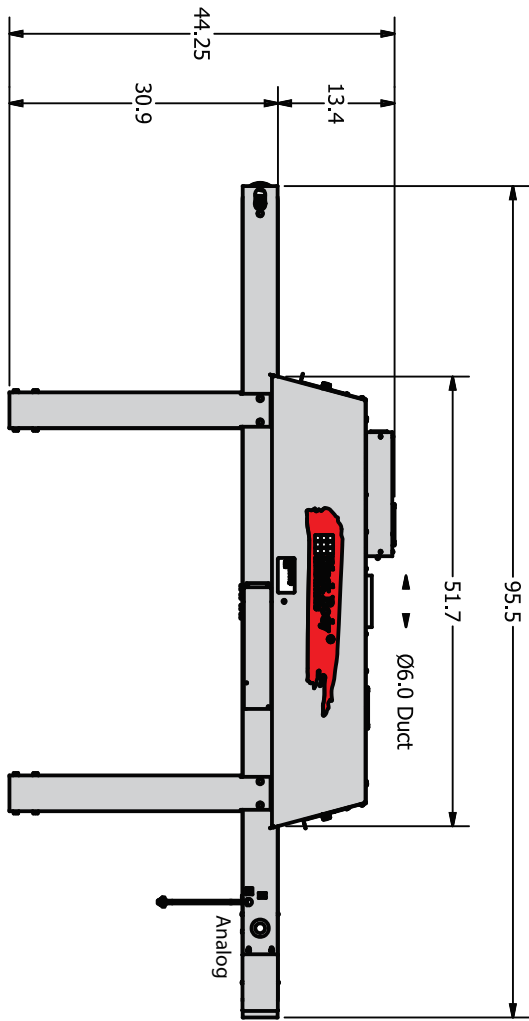
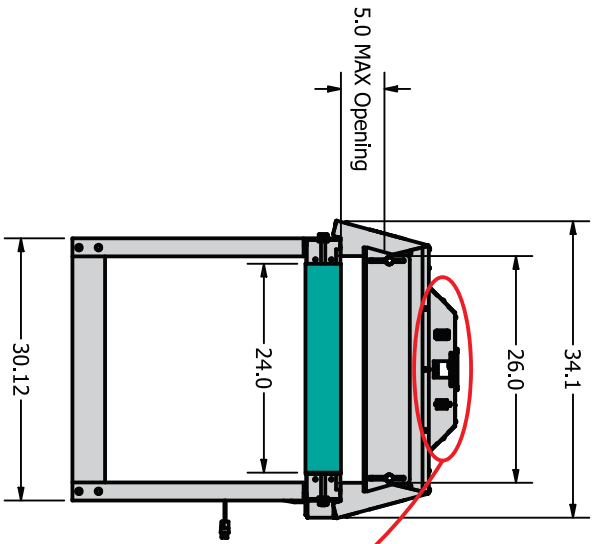

BBAIR-2408 dimensions





WATER BASE
PLASTSOL



HEATER SURFACE TEMPERATURE



HEAT
ON
OFF

Proprietary drawings, belonging to:



Black Body
INFRARED DRYING SYSTEMS®

BBC INDUSTRIES INC.
5 CAPPER DRIVE
PACIFIC, MO 63069 USA
636-343-5600 FAX 636-343-3952
800-654-4205 WWW.BBCIND.COM